



Brevini Fluid Power was established in 2003 in Reggio Emilia where there is the headquarter.

Brevini Fluid Power is among the top manufacturers in Italy of hydraulic components and is an important player in Europe and in the world thanks to its large range of products.



BPE FOCUS

**Product
customization**

**Software
Customization**

MISSION

Optimize machine operation with enhanced operator safety

Product Range



COMPLETE
CONTROL
SYSTEMS

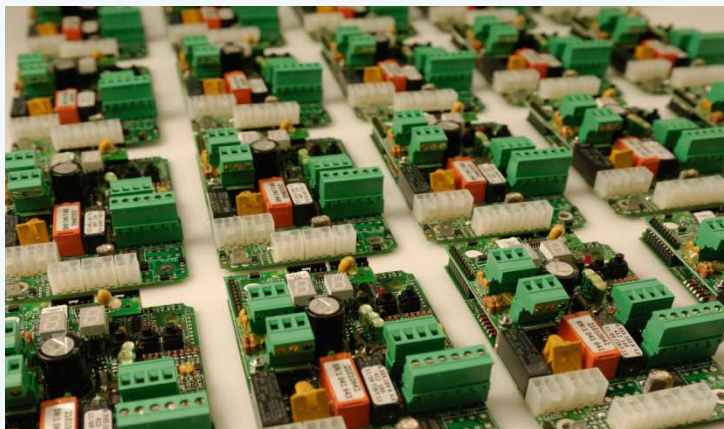

PROGRAMMABLE
ELECTRONIC
MODULES

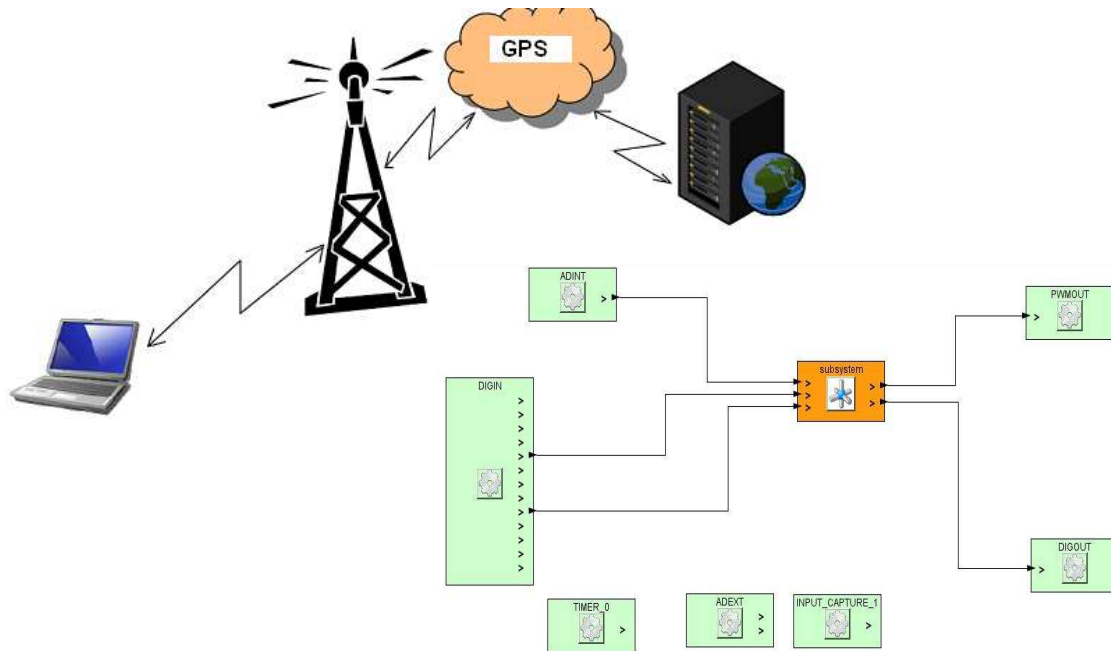

Complete Control Management

Product Range



POSITION SENSORS

Angle sensors
Tilt sensors
Length sensors



PRESSURE SENSORS

Product Range



LOAD SENSORS



**SINGLE PURPOSE
MODULES**

**Self leveling
Valve management
Overload control**

BPE & BFP

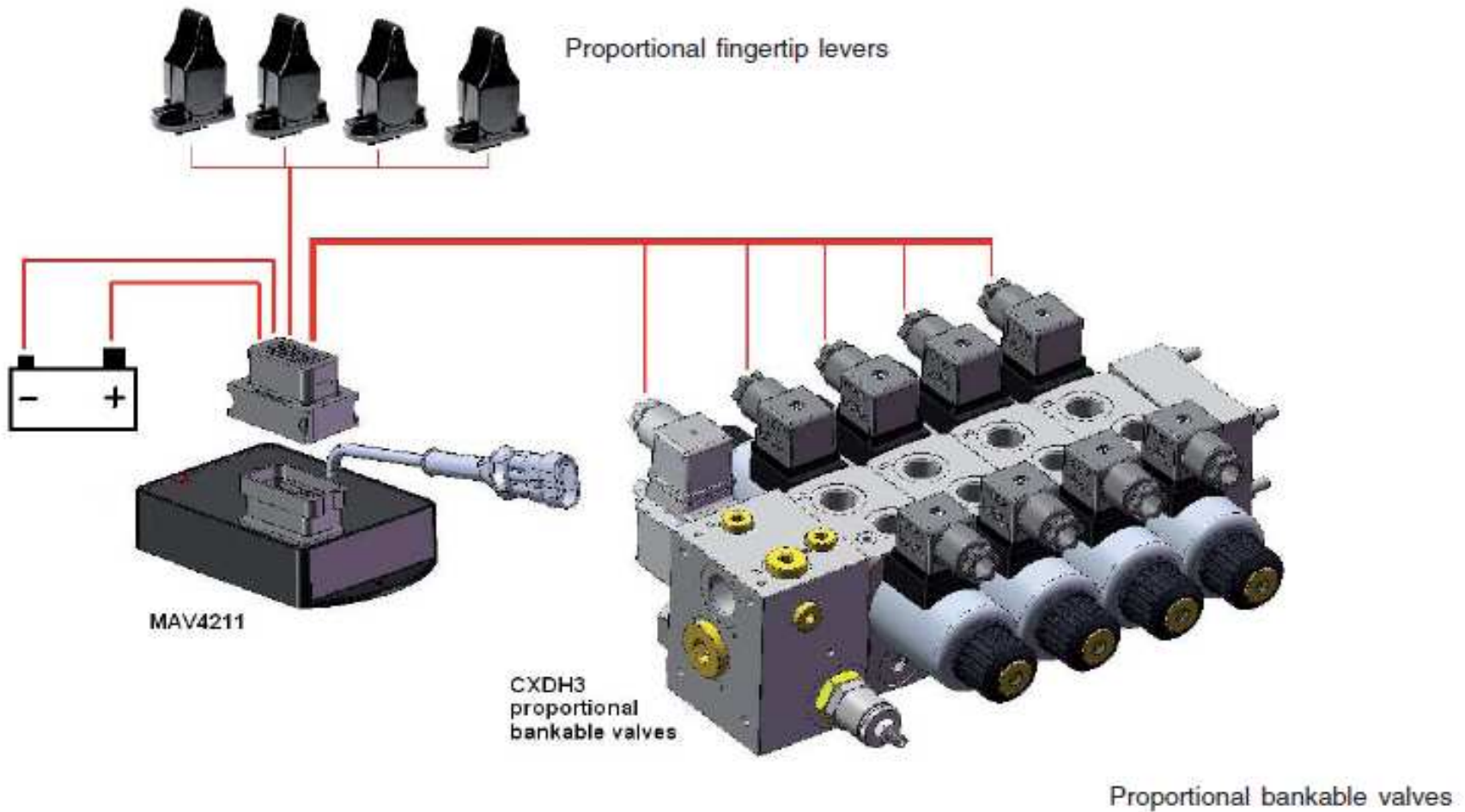

BPE & BFP

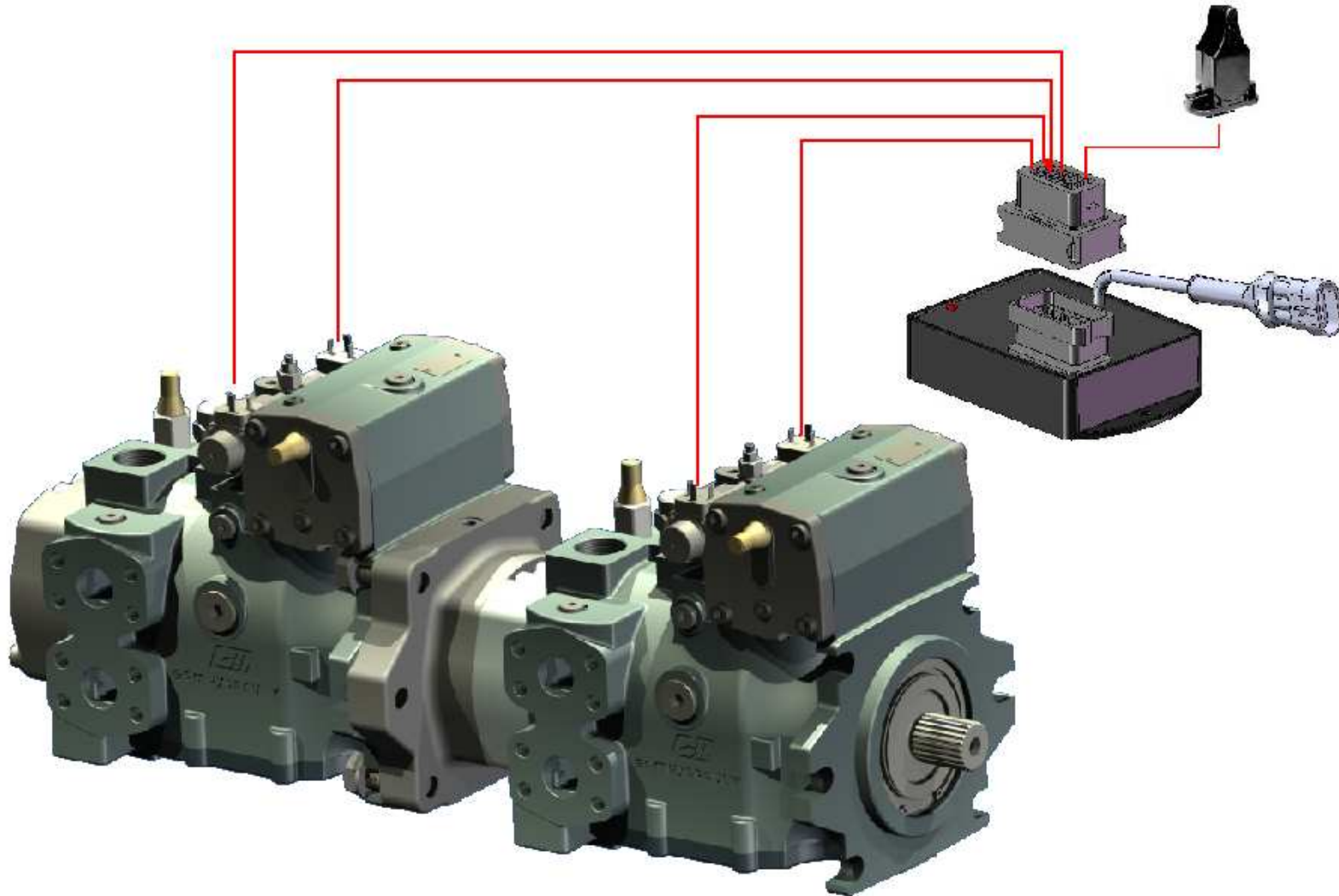

Quality and Certification

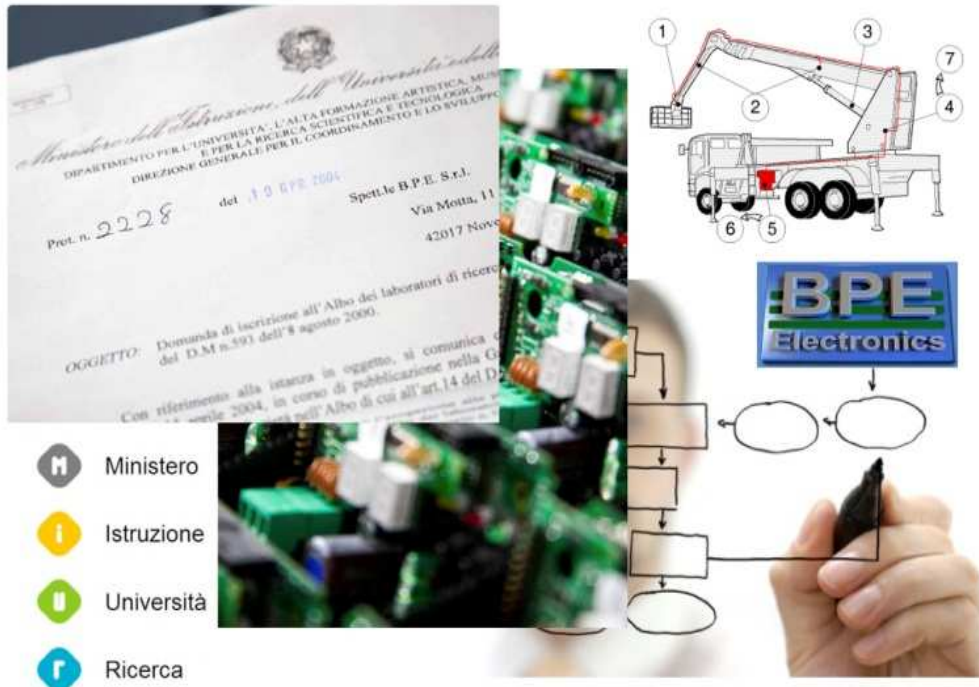

BPE products are in compliance with all safety and quality rules **EN13849-1**

Material Handling



Aerial Platform



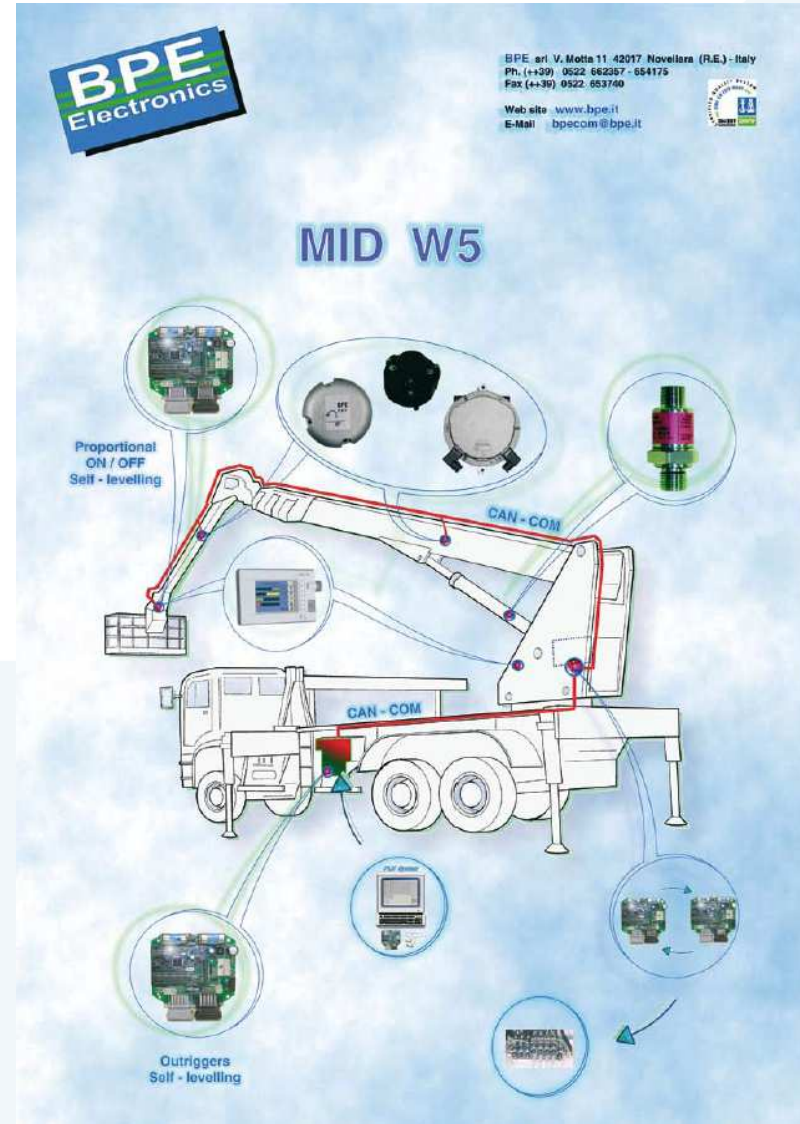
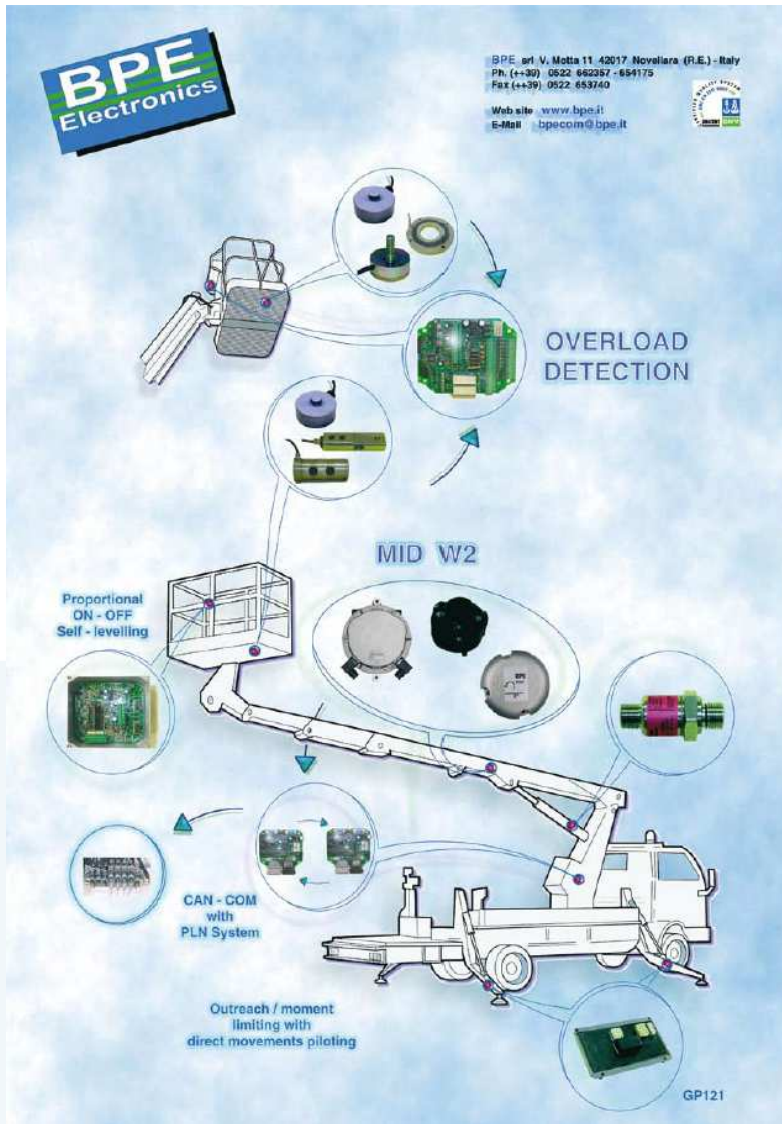

Material Handling



Aerial Platform







Material Handling



Truck Crane



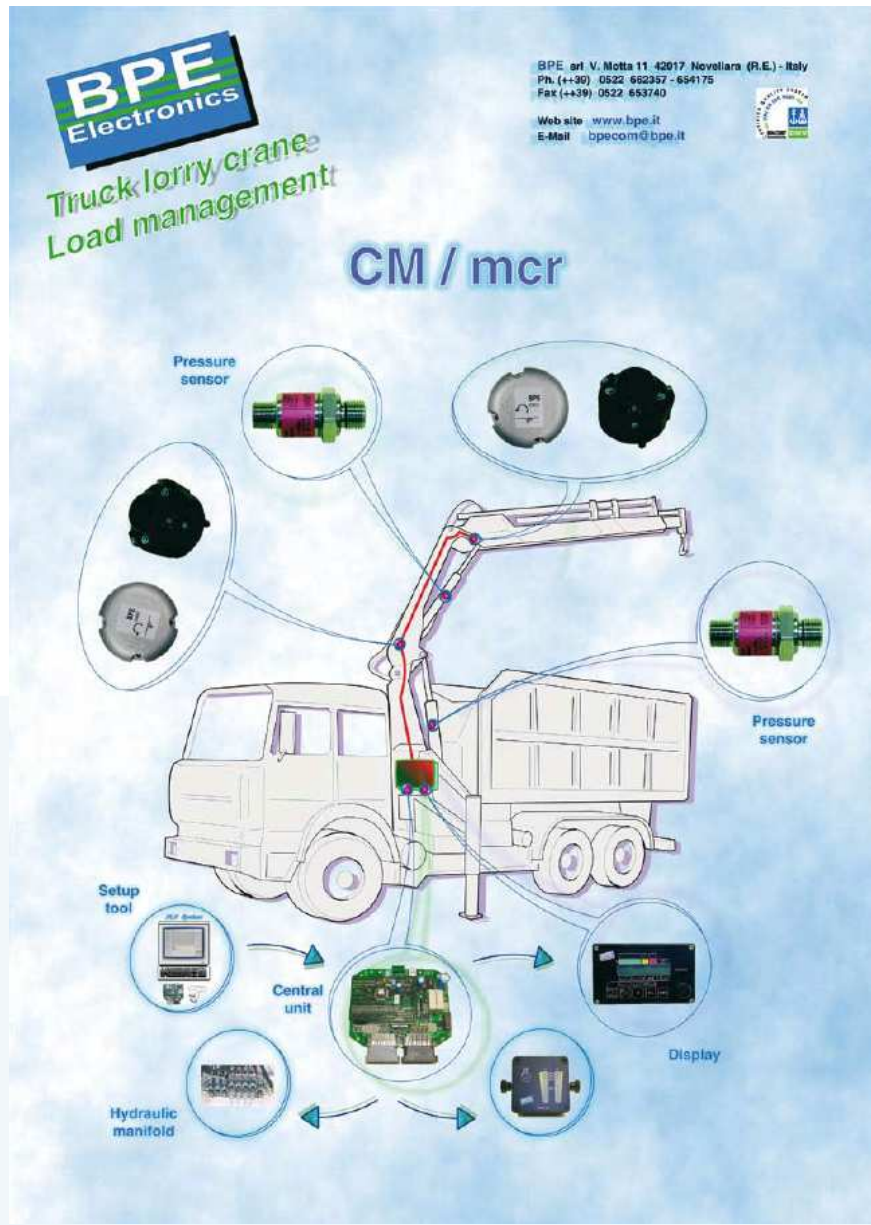

Construction

Tower Crane



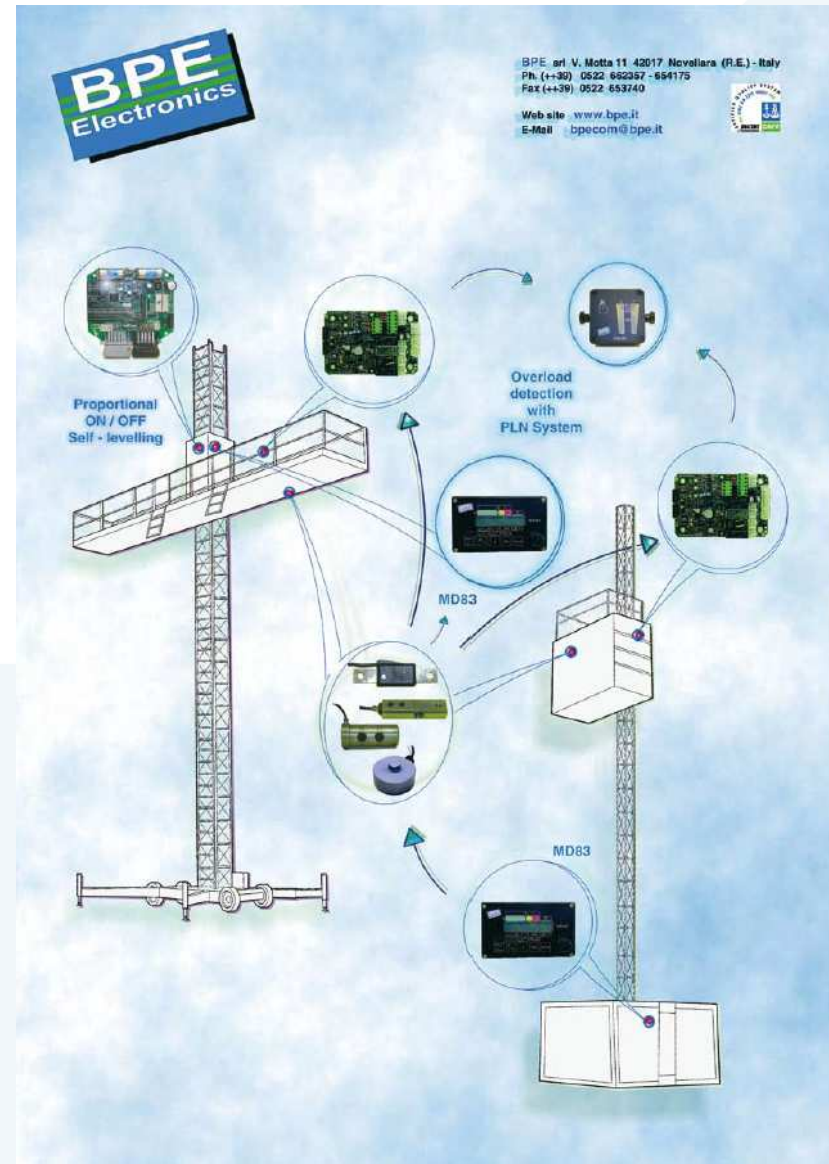

Marine

Marine Crane

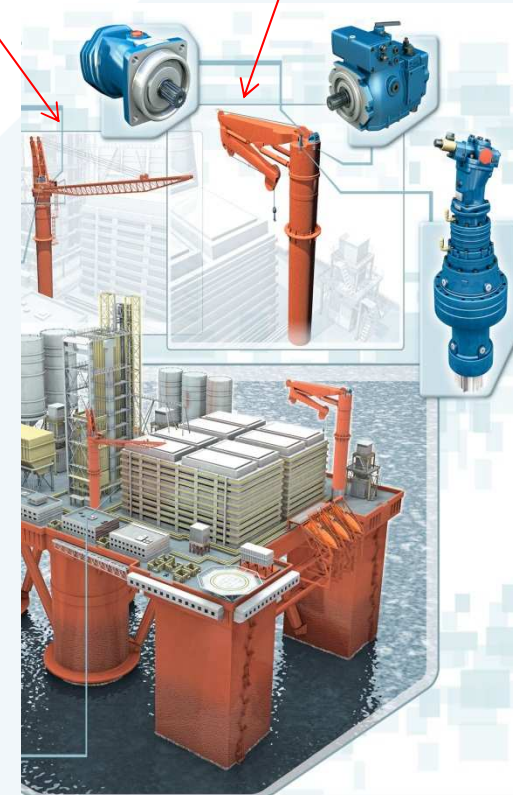
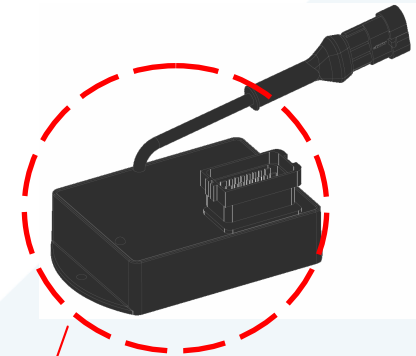

THANK YOU!